

TROUBLESHOOTING

AUTOMIZER CO-MINGLE RIGHT-HAND™

TROUBLESHOOTING

AUTOMIZER RIGHT-HAND™

Table of Contents

3.0	TROUBLESHOOTING	3 - 5
3.1	INTRODUCTION	3 - 5
3.2	HAND TOOLS REQUIREMENT	3 - 7
3.3	TROUBLESHOOTING GUIDE	3 - 8
3.4	PUMP TROUBLESHOOTING	3 - 15
3.5	PUMP CAVITATION	3 - 17
3.6	PACKER AIR SYSTEM TROUBLESHOOTING	3 - 18
3.7	PACKER MODULE TROUBLESHOOTING	3 - 22
3.8	PACKER MULTI-CYCLE MODULE PROGRAMMING	3 - 25
3.9	PACKER MULTI-CYCLE MODULE TROUBLESHOOTING	3 - 26
3.10	ELECTRIC SCHEMATICS SYMBOLS	3 - 30
3.11	ALLISON TRANSMISSION PROGRAMMING PARAMETERS	3 - 31
3.12	ENGINE PROGRAMMING PARAMETERS	3 - 32
3.13	CYLINDER INTERNAL LEAK DETECTION	3 - 33
3.14	TAILGATE LOCKING MECHANISM TROUBLESHOOTING	3 - 34
3.15	MAIN HYDRAULIC SCHEMATIC	3 - 38
3.16	AUTOMATED ARM HYDRAULIC SCHEMATICS	3 - 40

3.0 TROUBLESHOOTING

3.1 INTRODUCTION

This section contains information that will help Labrie end users to narrow down and solve problems that might occur on the AUTOMIZER™ unit. Procedures throughout this section require from the people who will perform troubleshooting tasks, to have basic knowledge in electrical, hydraulic and pneumatic systems. The employer shall ensure that the maintenance personnel are trained prior to beginning troubleshooting. Before proceeding to some maintenance on a vehicle, make sure that all safety procedures are applied. The lockout/tagout procedure outlined in the Operator's Manual is mandatory to ensure the safety of those who work on and around the vehicle.

Refer to [section 3.3](#) "Troubleshooting Guide" in order to resolve commonly seen problems or contact the Labrie Customer Support Center to talk to one of our product specialists.

NOTE: The schematics provided in this manual are for reference only. Please refer to the schematics provided with the truck (in the cab) to perform maintenance and troubleshooting tasks, as they are specific to the truck.



Labrie Customer Support Center
Parts, Service and Warranty
(during business hours)

Technical Support Service
(24 hours)

1-800-231-2771
54 Park Place (Upper)
Appleton, WI 54914

3.2 HAND TOOLS REQUIREMENT

To pinpoint the cause of a problem on a vehicle, some hand tools are necessary to perform tests on components (pneumatic, hydraulic or electrical). Here is a list and pictures of the minimum required tools to perform troubleshooting procedures throughout this manual. These are only suggestions; product brand names may differ.

Required hand tools

Digital Multimeter or VOM: (Volt-Ohm-Milliammeter)

Note:

The ammeter must support at least 10 amps



Figure #3.1

Jumper wire with alligator clips

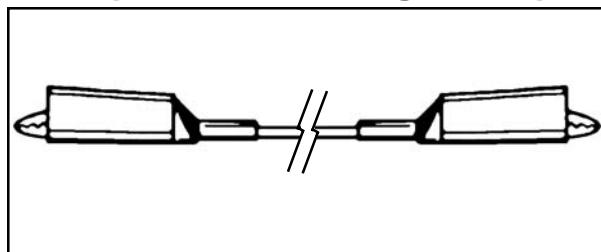

Figure #3.2

Two oil gauges (0-4000psi)

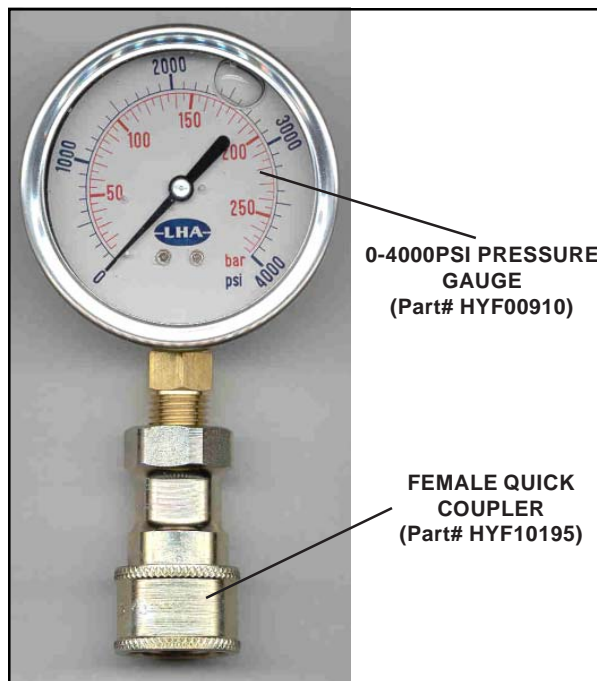

Figure #3.3

Ball-end Hex Key (Metric & SAE)

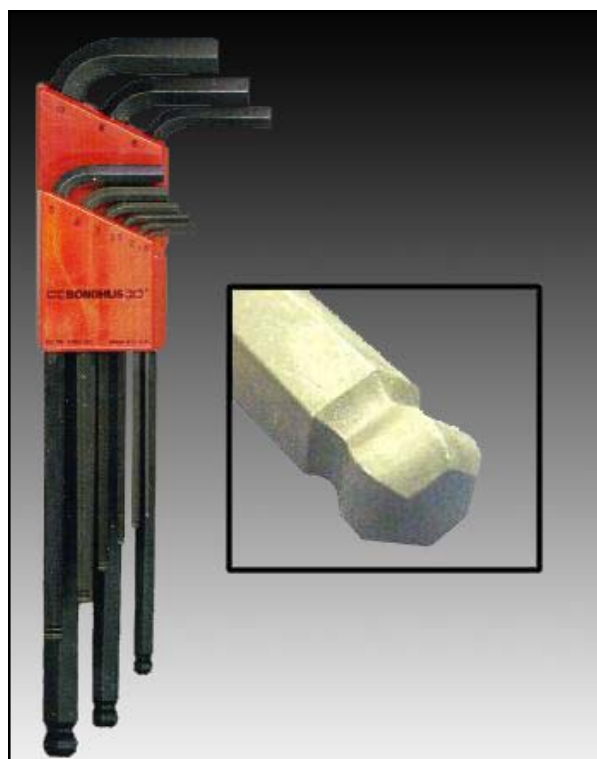

Figure #3.4

3.3 TROUBLESHOOTING GUIDE

This troubleshooting guide will help identify the most commonly seen problems on the Labrie AUTOMIZER™. This table will also provide the possible cause of the problem and give solutions to resolve the problem. For further information regarding customized options that might not be found in this troubleshooting guide, contact the Labrie Technical Support Service.

PROBLEM	POSSIBLE CAUSE(S)	SOLUTION(S)
<ul style="list-style-type: none"> Insufficient packing ratio. 	<ol style="list-style-type: none"> Low oil pressure; The packer hydraulic cylinders are internally bypassing; Defective pump. 	<ol style="list-style-type: none"> Perform hydraulic pressure adjustment procedure. Refer to section 1.15 "Hydraulic Pressure adjustment" for procedure. Refer to section 3.13 "Internal leak detection". Replace the pump.

PROBLEM	POSSIBLE CAUSE(S)	SOLUTION(S)
<ul style="list-style-type: none"> The hydraulic oil is over heating (Temperature higher than 180°F (77°C)). 	<ol style="list-style-type: none"> Oil level in hydraulic tank is too low; Hydraulic pressure is too low or too high; Not the proper grade of oil. (i.e.: too thin in hot temperatures or too thick in cold temperatures); Contaminated oil; Restriction in the system; 	<ol style="list-style-type: none"> Add oil to the required level. Refer to section 1.14.5 "Hydraulic tank inspection procedure". Perform the hydraulic pressure adjustment procedure. Refer to section 1.15 "Hydraulic Pressure adjustment" for procedure. See section 2.1 "Recommended Lubricants" for proper type oil to use. Refer also to section 1.14.6 "Hydraulic oil replacement procedure". Clean the strainer inside the tank and change the return filter element. Fill with clean oil. Refer to section 1.14.6, 1.14.7 & 1.14.8. Check all hydraulic components that may have debris, causing restriction in the system. Have the pump inspected by a specialist.

3.3 TROUBLESHOOTING GUIDE (Cont'd)

PROBLEM	POSSIBLE CAUSE(S)	SOLUTION(S)
<ul style="list-style-type: none"> Oil is foaming 	<ol style="list-style-type: none"> Low oil level; Air getting into the system; Not the proper grade of oil. 	<ol style="list-style-type: none"> Add oil to the required level. Refer to section 1.14.5 "Hydraulic tank inspection procedure". Tighten the connections of all hoses and pipes between the pump and the hydraulic tank. Empty oil and refill with anti-foaming oil. Refer to section 2.1 "Recommended Lubricant" for the proper type of oil to use. Refer also to section 1.14.6 "Hydraulic oil replacement procedure".

PROBLEM	POSSIBLE CAUSE(S)	SOLUTION(S)
<ul style="list-style-type: none"> Cavitation, excessive noise or vibration of the pump. 	<ol style="list-style-type: none"> Ball valve on the hydraulic tank is not fully open; Low oil level; Oil too thick; Air in the system; Particle contamination or dirty strainer; Suction hose blocked; 	<ol style="list-style-type: none"> Fully open the ball valve on the hydraulic tank. Refer to section 1.9 "Prior to start up". Add oil to the required level. Refer to section 1.14.5. See section 2.1 "Recommended Lubricants" for proper type oil to use. Refer also to section 1.14.6 "Hydraulic oil replacement procedure". Refer to section 3.5 "Pump Cavitation". Clean the strainer inside the tank and change the return filter. Fill with clean oil. Refer to section 1.14.6, 1.14.7 & 1.14.8. Take an oil sample for further analysis. Refer to section 2.1.5 "Hydraulic oil test" Unblock or replace the hose.

3.3 TROUBLESHOOTING GUIDE (Cont'd)

PROBLEM	POSSIBLE CAUSE(S)	SOLUTION(S)
<ul style="list-style-type: none"> The pump (PTO) does not engage. 	1. Air pressure;	1. Make sure the air pressure is above 70 PSI.
	2. Red emergency stop button(s);	2. Ensure that the red button on packer control station is pulled out.
	3. Engine speed is higher than 900 RPM;	3. Reduce engine speed below 900 RPM. If the RPM cannot be reduced under 900RPM, contact your local chassis dealer.
	4. Electrical;	4. Check fuses inside the console and the main fuses located at the battery. Refer to section 3.4 "Pump troubleshooting".
	5. Faulty electrical dump valve.	5. Replace the electrical dump valve

PROBLEM	POSSIBLE CAUSE(S)	SOLUTION(S)
<ul style="list-style-type: none"> No hydraulic pressure. 	1. Pump is not engaged;	1. Turn the PTO switch "ON".
	2. Pressure adjustment;	2. Check the pressure adjustment. Refer to section 1.15 "Hydraulic Pressure adjustment" for procedure.
	3. Hydraulic line;	3. Perform a circuit analysis with the main hydraulic schematics section 3.15 or section 3.16 .
	4. Hydraulic spool inside the valve.	4. Make sure that no spool inside the directional valve is stuck in a position that could send the hydraulic flow to the tank.
	5. Faulty electrical dump valve.	5. Replace the electrical dump valve.

PROBLEM	POSSIBLE CAUSE(S)	SOLUTION(S)
<ul style="list-style-type: none"> The pump is leaking oil. 	1. Loose connections;	1. Tighten all connections at the pump.
	2. The pump shaft seal is damaged.	2. Have the pump repaired by an authorized service center.

3.3 TROUBLESHOOTING GUIDE (Cont'd)

PROBLEM	POSSIBLE CAUSE(S)	SOLUTION(S)
<ul style="list-style-type: none"> The packer is moving vertical or sideways. 	<ol style="list-style-type: none"> The packer wear pads have too much wear; Sliding shoes have too much wear. 	<ol style="list-style-type: none"> Inspect or replace the wear pad as indicated in section 1.12.5. Inspect or replace the sliding shoes as indicated in section 1.12.3 1.12.4.

PROBLEM	POSSIBLE CAUSE(S)	SOLUTION(S)
<ul style="list-style-type: none"> The tailgate is unlocking or lowering by itself. 	<ol style="list-style-type: none"> The velocity fuse is dirty or defective; Inverted hydraulic hoses on the main hydraulic valve. 	<ol style="list-style-type: none"> Clean or replace the velocity fuse. Refer to section 3.14 "Tailgate locking mechanism troubleshooting". Test the "power bleed" on the tailgate section of the valve. Refer to section 3.14 "Tailgate locking mechanism troubleshooting".

PROBLEM	POSSIBLE CAUSE(S)	SOLUTION(S)
<ul style="list-style-type: none"> The packer does not complete a full cycle. 	<ol style="list-style-type: none"> Body is full, preventing the packer from reaching the fully extended position; An accumulation of garbage behind the packer prevents the packer from reaching the fully retracted position; Packer limit switch operation affected by debris or out of adjustment; Air control systems might be defective. 	<ol style="list-style-type: none"> Empty the body. Refer to the Operator's Manual section 3.4.9 "Breaking the load". Clean behind the packer. Refer to section 1.11 "Cleaning the hopper area". Clean the area around the limit switches. Refer to section 1.12.2 "Limit switch adjustment". Refer to section 3.6 "Packer air system troubleshooting".

3.3 TROUBLESHOOTING GUIDE (Cont'd)

PROBLEM	POSSIBLE CAUSE(S)	SOLUTION(S)
<ul style="list-style-type: none"> The packer does not start at all when pressing "Start Cycle" (green) button. 	1. PTO switch;	1. Make sure the PTO switch is turned "ON".
	2. Emergency Stop buttons (red);	2. Make sure all Emergency Stop buttons (red) are pulled out.
	3. Packer control station not selected;	3. See if the packer control station selector switch is properly set to the one you are using.
	4. Air system;	4. Make sure the air pressure is at least 70 PSI.
	5. Hydraulic;	5. Ensure that the hydraulic pressure is properly adjusted.
	6. Faulty harness between the packer module and the packer control station.	6. Refer to section 3.7 "Packer module troubleshooting".
	7. Defective packer module.	7. Refer to section 3.7 "Packer module troubleshooting".

PROBLEM	POSSIBLE CAUSE(S)	SOLUTION(S)
<ul style="list-style-type: none"> The packer is moving forward when pressing the GREEN button, but stops when releasing the button. 	1. Faulty packer module;	1. Refer to section 3.7 "Packer module troubleshooting".
	2. Faulty harness between the packer module and the console.	2. Refer to section 3.7 "Packer module troubleshooting".

PROBLEM	POSSIBLE CAUSE(S)	SOLUTION(S)
<ul style="list-style-type: none"> The packer is moving forward, but stops at the end of the stroke. 	1. Air solenoid valve is faulty;	1. Manually override the air valve coils to see if the problem is the electrical signal. Refer to section 3.7 "Packer module troubleshooting".
	2. Faulty packer module;	2. Refer to section 3.7 "Packer module troubleshooting".
	3. Dirty or defective air actuator on the main hydraulic valve;	3. Clean or replace if necessary
	4. Leaking "o-ring" on the air actuator piston;	4. Replace the o-ring and lubricate.

3.3 TROUBLESHOOTING GUIDE (Cont'd)

PROBLEM	POSSIBLE CAUSE(S)	SOLUTION(S)
<ul style="list-style-type: none"> The packer is moving backwards when pressing the "Retract" (yellow) button, but stops when releasing the button. 	<ol style="list-style-type: none"> Faulty packer module; Faulty harness between the packer module and the console. 	<ol style="list-style-type: none"> Refer to section 3.7 "Packer module troubleshooting". Refer to section 3.7 "Packer module troubleshooting".

PROBLEM	POSSIBLE CAUSE(S)	SOLUTION(S)
<ul style="list-style-type: none"> Packer does not perform enough cycles 	<ol style="list-style-type: none"> Multi-cycle module programming. 	<ol style="list-style-type: none"> Reprogram the module for higher number of cycles. Refer to section 3.8 "Packer multi-cycle module programming".

PROBLEM	POSSIBLE CAUSE(S)	SOLUTION(S)
<ul style="list-style-type: none"> The backup alarm and the warning buzzer inside the cab work all the time. 	<ol style="list-style-type: none"> Tailgate limit switch out of adjustment; Body raised limit switch out of adjustment; Limit switch; Faulty harness 	<ol style="list-style-type: none"> Adjust the limit switch arm with the tailgate cylinder. Refer to section 1.13.5 "Tailgate limit switch". Adjust the limit switch arm with the body floor. Refer to section 1.13.4 "Body raised limit switch adjustment". Check the limit switch with a multimeter or VOM for proper operation (ON/OFF or click). Check for continuity on the electrical harness that is connected to the limit switch. Change the electrical harness if necessary.

3.3 TROUBLESHOOTING GUIDE (Cont'd)

PROBLEM	POSSIBLE CAUSES	SOLUTION
<ul style="list-style-type: none"> The arm is too fast. 	<ol style="list-style-type: none"> Flow limiter on the proportional valve not properly adjusted. 	<ol style="list-style-type: none"> Re-calibrate cylinder's speed (see section 1.15.5 "Arm speed adjustment").

PROBLEM	POSSIBLE CAUSE(S)	SOLUTION(S)
<ul style="list-style-type: none"> The arm is too slow. 	<ol style="list-style-type: none"> Flow limiter on the proportional valve not properly adjusted. 	<ol style="list-style-type: none"> Re-calibrate cylinder speed (see section 1.15.5 "Arm speed adjustment").

PROBLEM	POSSIBLE CAUSE(S)	SOLUTION(S)
<ul style="list-style-type: none"> Flashing lights on dashboard are always blinking. 	<ol style="list-style-type: none"> Limit switches not adjusted properly. Power cables are cut off or defective. One limit switch(or both) is faulty. 	<ol style="list-style-type: none"> Aligned the lever with the grabber finger (see section 1.17.3 "Grabber Limit Switch"). Perform a continuity test on the cable or change faulty cables. Replace faulty limit switches.

PROBLEM	POSSIBLE CAUSE(S)	SOLUTION(S)
<ul style="list-style-type: none"> The arm does not respond to joystick (Assuming that PTO switch and light are On). 	<ol style="list-style-type: none"> Arm control fuse(s) burned. Power cables are cut off or defective. Faulty joystick. 	<ol style="list-style-type: none"> Check fuses in the console. Follow wires on the electrical schematic for 12 volts supply (Move joystick to get signals). Contact customers services at Labrie.

3.4 PUMP TROUBLESHOOTING

The pump is operated using a control switch located on the console. Also, a red warning light indicates when the pump is engaged. Two conditions must be met for the pump to be engaged and the warning light to turn ON:

- 1) Air pressure of 70 PSI
- 2) Engine speed lower than 900RPM

The air pressure condition is verified by a pressure switch while the engine speed (900RPM) is verified by the transmission ECU

If the pump does not engage when the pump (PTO) switch is turned "ON", it may be related to a voltage supply problem in the pump circuitry.

The following test will help resolve pump related problems. Prior to begin testing, ensure that all these conditions are met:

- 1) Parking brake applied;
- 2) Engine is running (idle speed);
- 3) Transmission in "Neutral";
- 4) Emergency red button pulled out;
- 5) Pump(PTO) switch "ON";

Refer to the electrical schematic #Z79450 (Figure #3.6) to follow the numbered test points. A test light or a multimeter (VOM) may be used by connecting the negative probe on the ground post (Single screw in the console on which all the ground wire (#105) are connected to.), and by taking a reading with the positive probe at each test point.

Note:

It is not recommended to strip or to poke



FIGURE #3.5

through wires to perform tests as this could create shorts and/or wire deterioration test directly in connector and switches

The transmission ECU is used as an interlock or safety for the PTO signal (12V input on wire #104). If the engine RPM is higher than 900RPM, the transmission ECU will not allow the output signal (12V output on wire #149) preventing the pump from engaging at high RPM.

The transmission ECU will wait until the throttle drops under 900RPM, allowing the 12-volt output signal on wire #149 (test point 15).

Continue following the path until reaching the last test point. If one of the test points failed, try to pinpoint the source of the shortage between the previous test point and the failing test point.

NOTE:

Neither the engine throttle nor the transmission not being in Neutral will affect the pump operation once the pump is engaged.

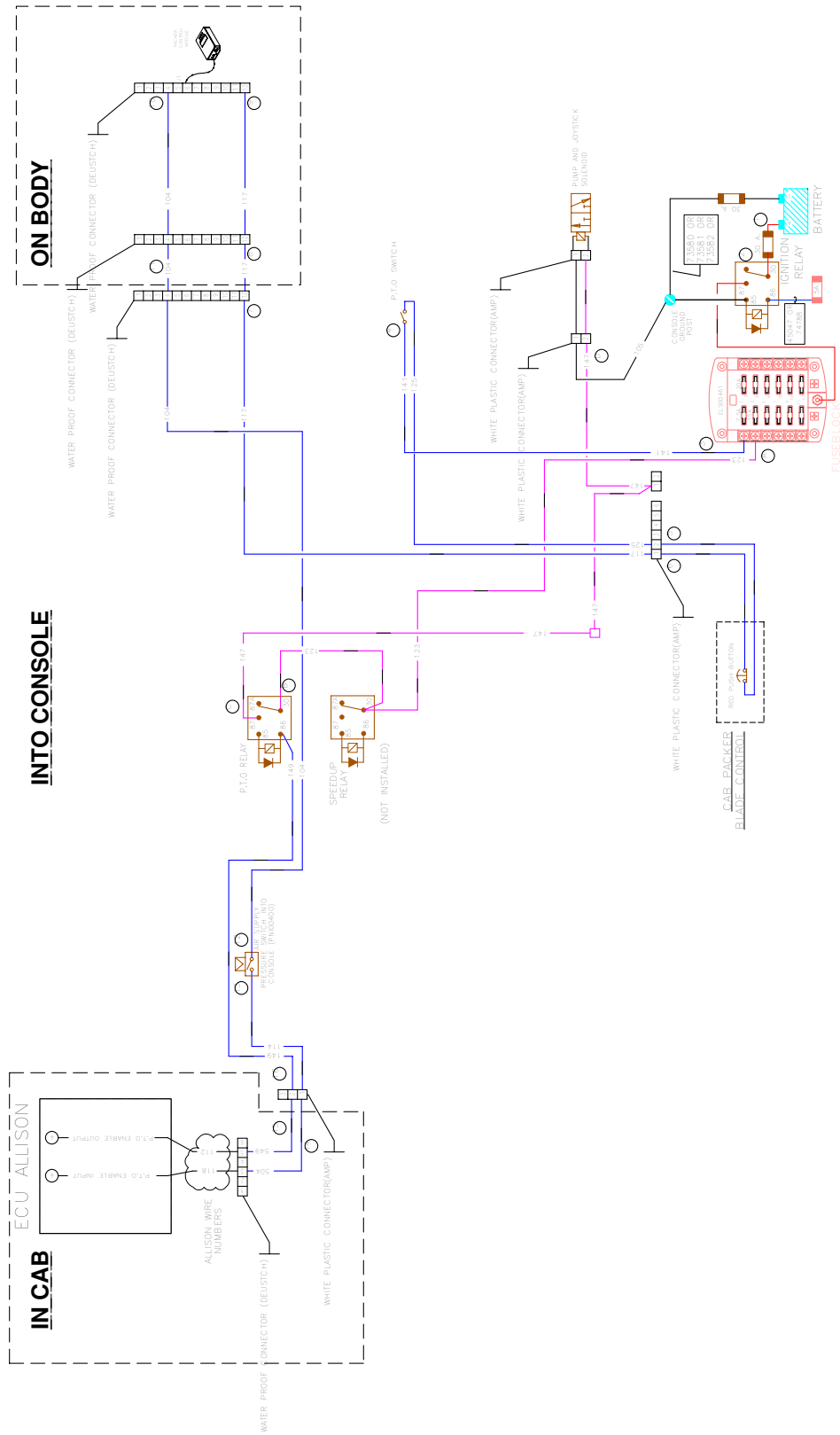

FIGURE #3.6

3.5 PUMP CAVITATION

Cavitation is defined as the formation of air pockets in a moving fluid. The presence of air in the hydraulic oil produces cavitation inside the pump, generating excessive wear and noise. Cavitation is forming most of the time after replacing hydraulic components or after flushing the hydraulic system. Make sure to prime the pump properly after its replacement. When the pump is properly primed, the cavitation will disappear after a short time because air is returning to the hydraulic tank.

Though, if the pump is still generating unusual noise after performing the priming procedure, apply the following procedure to remove residual air pocket from the system.

HYDRAULIC SYSTEM BLEEDING PROCEDURE

1. Apply all safety measures to ensure safety around the vehicle at all times.
2. Connect a 0-4000PSI gauge to the main valve to ensure that no pressure build-up is present in the system.
3. Apply the parking brake.
4. Start the engine.
5. Engage the hydraulic pump (PTO switch "ON").

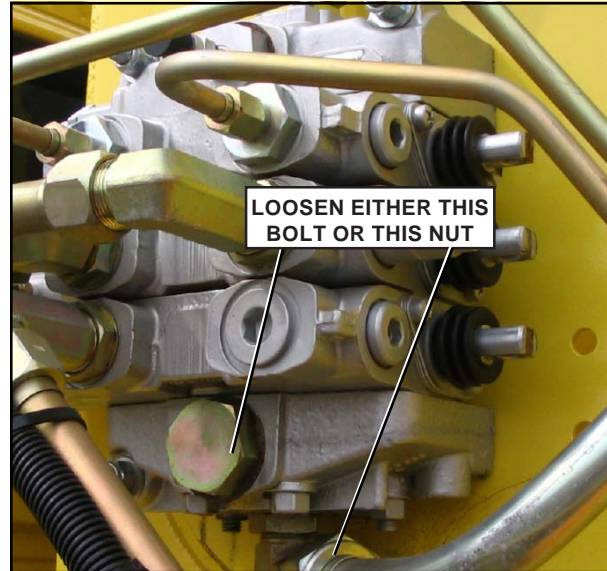

FIGURE #3.7

HYDRAULIC SYSTEM BLEEDING PROCEDURE

6. Slowly loosen either the bolt located on the main control valve's output section or the nut located on the output hose of the valve (Figure #3.7). A mixture of oil and air will come out. Keep bleeding the oil until the pump noise stops. **DO NOT ACTIVATE ANY HYDRAULIC FUNCTION DURING SYSTEM BLEEDING.**
7. Use a pan or a bucket to recuperate the oil.
8. Tighten the pipe/hose fitting when the noise has stopped.
9. Cycle the packer to ensure that there is no leaks and the pump is running smoothly.
10. Disconnect the gauge.

3.6 PACKER AIR SYSTEM TROUBLESHOOTING

How it works:

The hydraulic valve which controls some of the vehicle's hydraulic functions is equipped with air actuators (Figure #3.8). The packer air actuator pushes back and forth on the hydraulic spool of the valve, resulting in a movement of the packer (extend or retract).

As the packer reaches the end of a stroke, the limit switches located behind the packer will send the signal to the electronic module telling that the packer has reached the end of its stroke. The packer module will then operate the air solenoid valve inside the console (Figure #3.9) with a 12-volt signal (one signal for packer extend, one signal for packer retract). See also [section 3.7](#) "Packer module troubleshooting".

When receiving the 12-volt signal (extend or retract) from the module, the air solenoid valve inside the console (Figure #3.9)

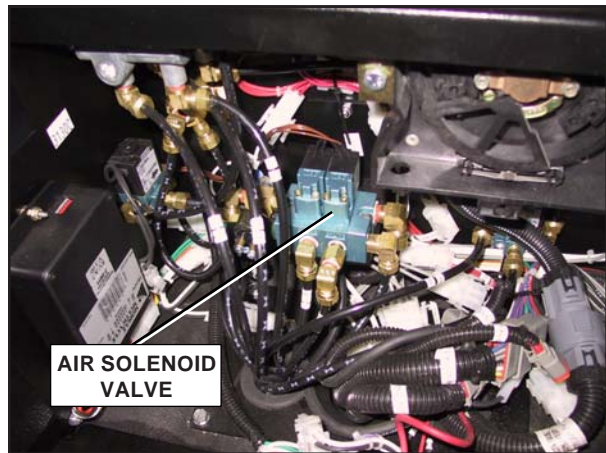

FIGURE #3.9

enables the air pressure to reach the actuator on the main control valve. Whether it is the retract or extend signal, the spool will move accordingly.

Four quick exhaust valves — two of which are located close to the body main valve (Figure #3.8) and two under the hoist cylinder (Figure #3.10) — are designed to release the air pressure from lines going to the packer air actuator installed on the main control valve. They release air when the packer reaches the end of a stroke allowing the spool to move in the opposite direction and to prevent working against pressurized lines.

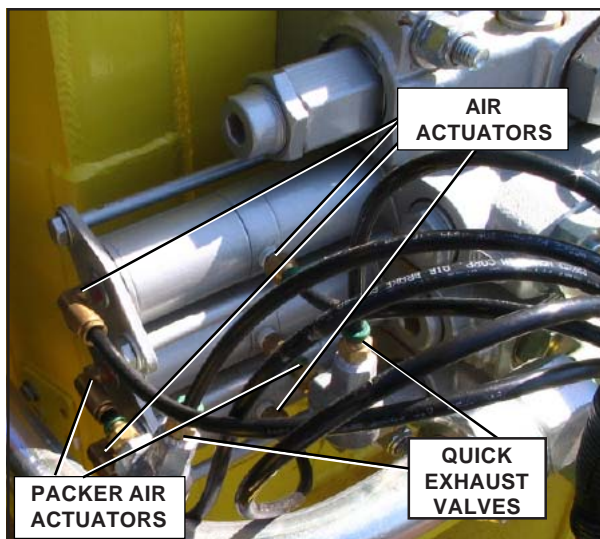

FIGURE #3.8

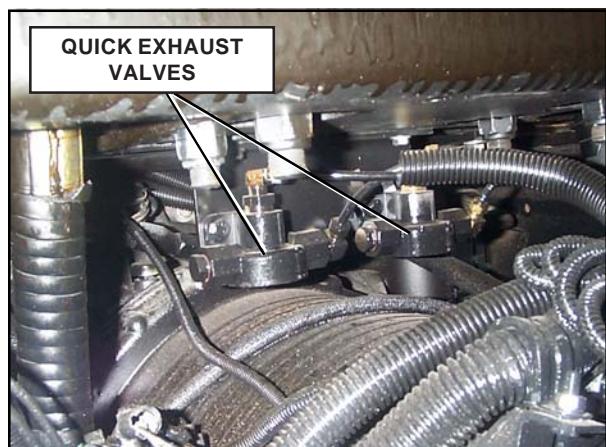

FIGURE #3.10

3.6 PACKER AIR SYSTEM TROUBLESHOOTING (Cont'd)

Troubleshooting:

If the packer does not complete a full cycle, it may be related to the air system. In order to resolve the problem, apply the following procedure:

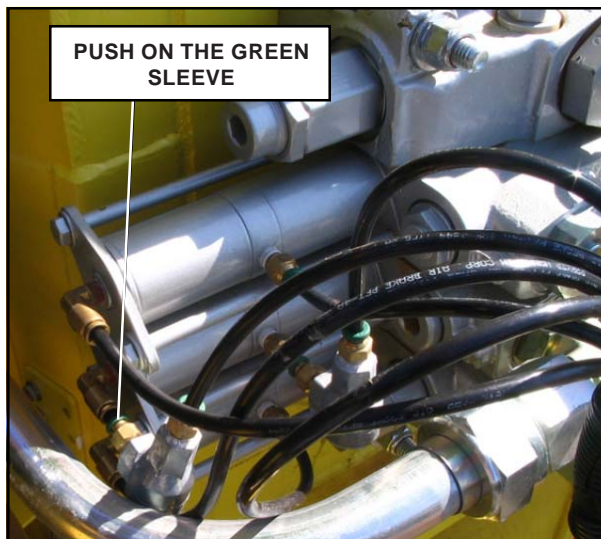

FIGURE #3.11

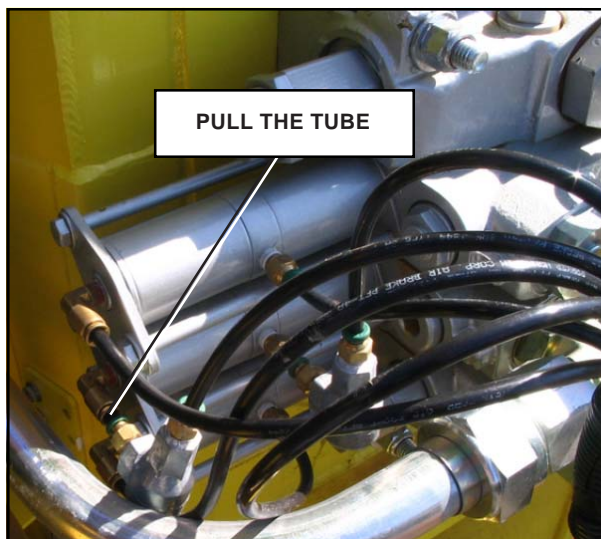

FIGURE #3.12

PACKER AIR SYSTEM TROUBLESHOOTING

1. Apply all safety measures to ensure safety around the vehicle at all times.
2. Remove the optional cover (if applicable) over the valve to get access to the air tubes.
3. Remove the air tube from the actuator, pushing on the green sleeve with a screwdriver (Figure #3.11). Pull the tube (Figure #3.12).
4. To ensure that the spool moves freely inside the valve, inject pressurized air in one side of the actuator (the same process will have to be done for the other side of the actuator) (Figure #3.13). If the spool is not moving freely, lubricate or replace the air actuator.

Note:

If air is leaking by the opposite port of the pressurized side of the actuator, when both hoses are removed, this could indicate that the o-ring on the piston of the air actuator is leaking. If needed disassemble clean and lubricate with grease or replace the o-ring.

5. If the spool is moving freely, try injecting air in the tube and see if air is exhausting from the quick exhaust valves underneath the body cylinder and close to the packer valve section actuator.
6. If not, see if air lines are not blocked or bent, then replace the quick exhaust valves if necessary.

3.6 PACKER AIR SYSTEM TROUBLESHOOTING (Cont'd)



FIGURE #3.13

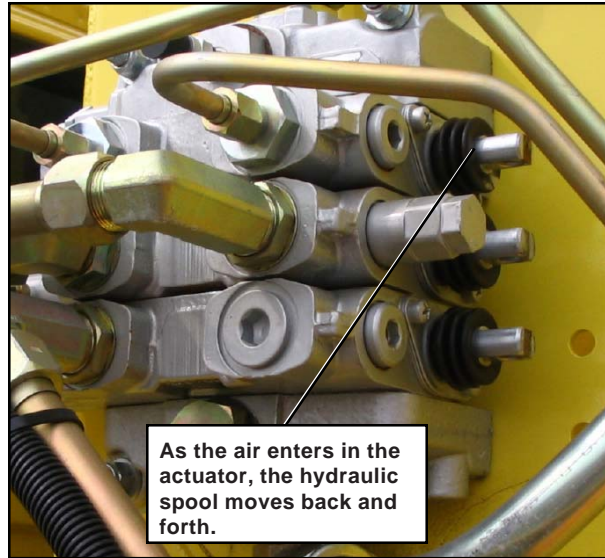

FIGURE #3.14

3.6 PACKER AIR SYSTEM TROUBLESHOOTING (Cont'd)

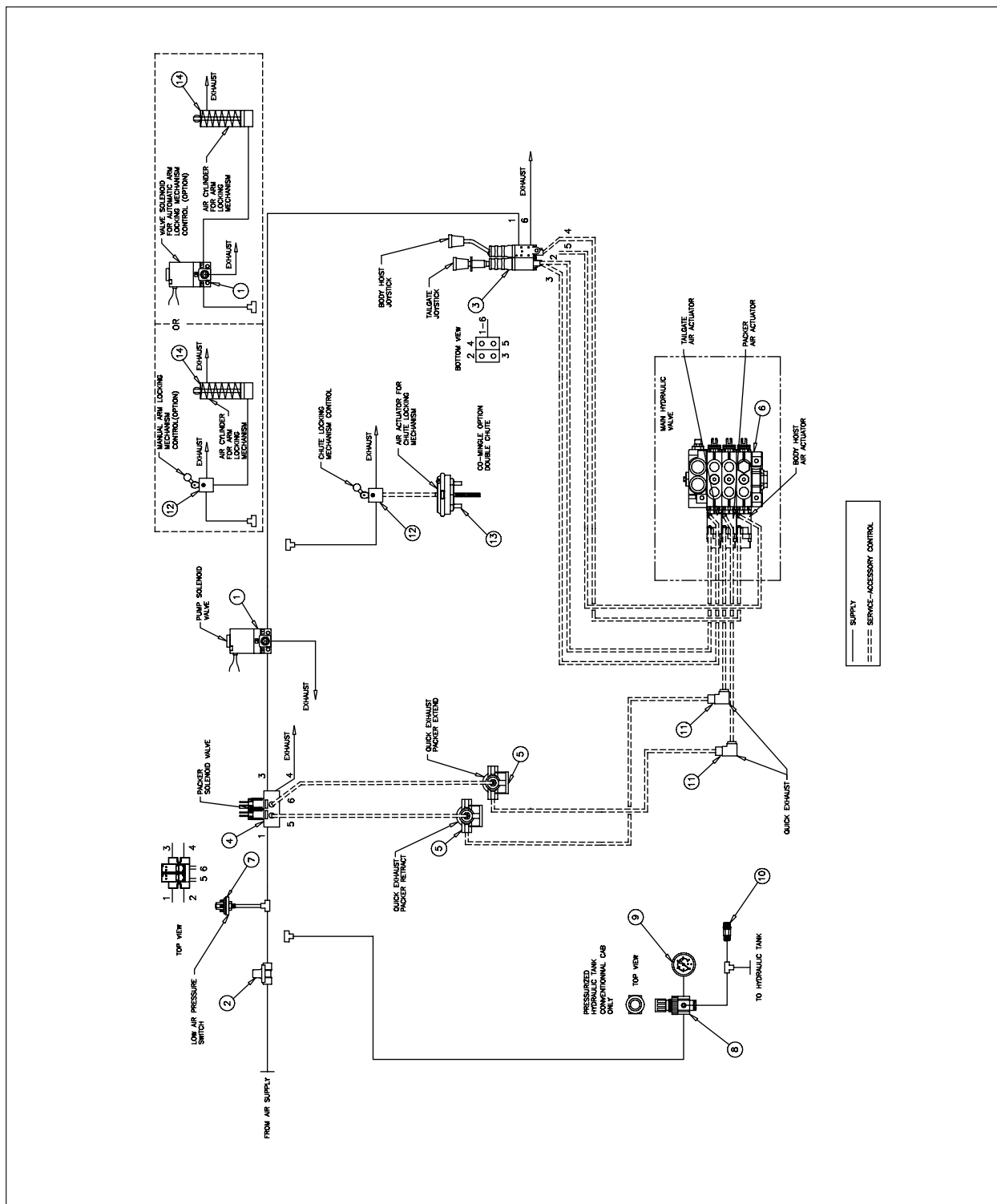

FIGURE #3.15

3.7 PACKER MODULE TROUBLESHOOTING

How it works:

Reference: Figure #3.27 or electrical schematic.

When pressing on “start cycle” button (green) on the packer control station, the packer module will send a 12-volt signal (packer extend) to the air solenoid valve inside the console (Figure #3.18). That signal allows the solenoid valve to move the air actuator on the hydraulic valve, causing the packer to move forward until it reaches the end of the stroke.

At the end of the stroke, the limit switch located on the L-H side of the hopper (Figure #3.16) will signal the module to cut the 12-volt signal on wire #107 and to switch the signal (packer retract) on wire #106. The packer will stop and then retract to its initial position, completing a full cycle.

When the packer is returning to its initial position, the limit switch located on the right-hand side of the hopper will cut the 12-volt signal on wire #106 stopping the packer.



FIGURE #3.16

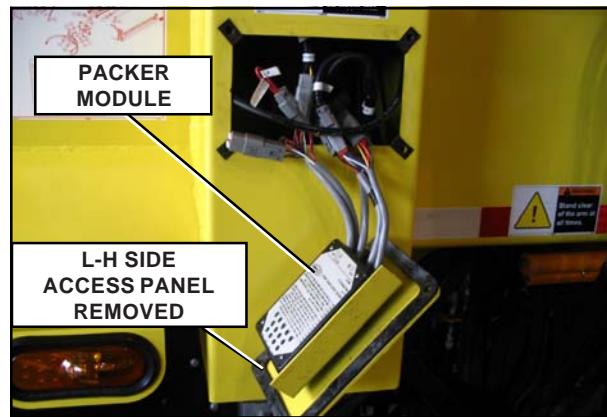

FIGURE #3.17

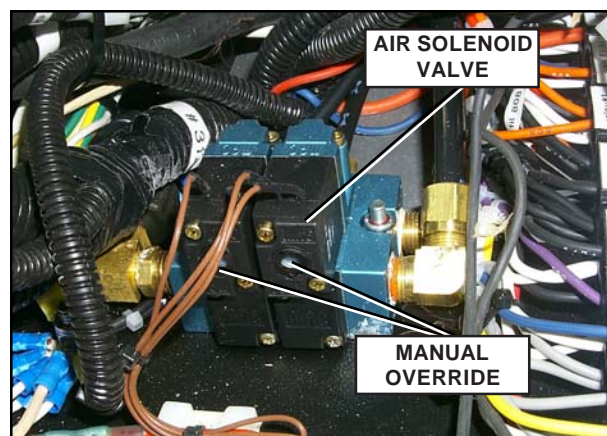

FIGURE #3.18

Continued on next page --->

3.7 PACKER MODULE TROUBLESHOOTING (Cont'd)

The packer module was designed with a set of LED's to indicate the status of the packer system. These LED's are used to monitor the activity of the packer module during a normal cycle. At any given time, each LED refers to an input or an output.

For example, if the "start cycle" button (green) is pressed, the LED "OUT 3" should turn "ON" and stay "ON" until the packer reaches the end of the stroke (Figure #3.19).



FIGURE #3.19

PACKER MODULE LED'S LAYOUT

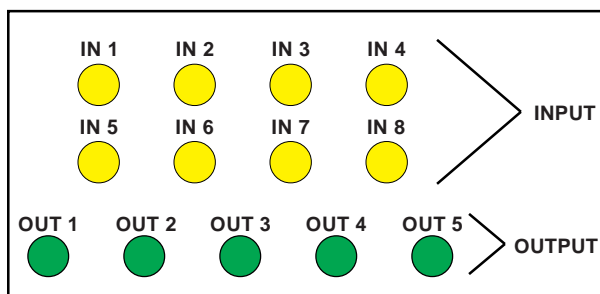

FIGURE #3.20

Refer to figure #3.22 for more information on LED'S layout of the packer module.

If the packer does not start at all or moves forward only when holding the "start cycle button (green), apply the following procedure to solve problem:

Note: This procedure also applies to the "retract" button (yellow).

PACKER MODULE TROUBLESHOOTING

1. **Apply all safety measures to ensure safety around the vehicle at all times.**
2. **Ensure that the parking brake is applied and start the engine.**
3. **Make sure all Emergency Stop Buttons (Red) are pulled out.**
4. **Remove the access panel on the R-H side of the hopper (Figure #3.17). This will give access to the packer module.**
5. **Start the engine.**
6. **Select the proper control station (for multiple packer control stations).**
7. **Press the "start cycle" button (green) or the "retract" button (yellow) on the packer control station (Left or right) and see if the LED "OUT 3" ("OUT 2" for "retract" button) on the module turns "ON" and stays "ON". If the LED does not stay "ON", REPLACE THE PACKER MODULE.**
8. **If the LED "OUT 3" ("OUT 2" for "retract" button) stays ON, and the packer does not move, the solenoid valve inside the console might be stuck or defective.**

9. Inside the console, press on the override button on the solenoid valve (Figure #3.17). The packer should be moving when manually overriding the valve. If not, make sure that the air lines are not blocked or bent (Also refer to [section 3.6](#) “Packer air system troubleshooting”);
10. When either LED “IN 7” or “IN 8” is “ON”, check for a 12-volt signal at the valve, coming from the packer module on wire #106 (packer extend) and wire #107 (packer retract). If the signal is present inside the console, remove, clean and inspect the valve, replace the solenoid valve if necessary;
11. However, if the LED on the module is “ON” and no signal is present inside the console, check the continuity of the electrical harnesses between the module and the console. Replace one or both harnesses if necessary.

In order to check the continuity between the packer module and the console, two harness sections require to be tested. The first section of the harness goes from the packer module to the body hinges, where a 12-pin connector can be found (Figure #3.26). The other section goes from the hinge at the rear of the vehicle and returns to the console in the cab.

Unplug the 12-pin connector, and test the continuity on wire #105, #106 and #107 using a multimeter or VOM. Note that a probe extension of 30 feet is necessary and two insulated alligator clips are required to connect the multimeter to both ends of the harness.

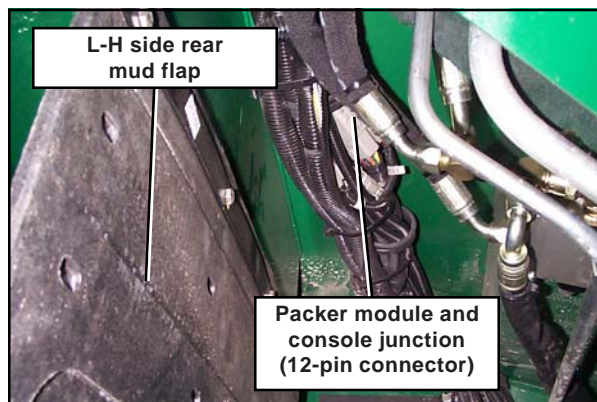

FIGURE #3.21

PACKER MODULE LED LAYOUT	
INPUT LED'S	<p>IN 1 : Main power input (Cut by in cab Emergency Stop button)</p> <p>IN 2 : Main power input (Cut by L-H side Emergency Stop button)</p> <p>IN 3 : R-H side packer control station (“ON” when selected)</p> <p>IN 4 : L-H side packer control station (“ON” when selected)</p> <p>IN 5 : R-H side speed-up switch “ON” (“Bunny button”)</p> <p>IN 6 : L-H side speed-up switch “ON” (“Bunny button”)</p> <p>IN 7 : Packer fully <u>retracted</u> limit switch (“ON” when “clicked”)</p> <p>IN 8 : Packer not fully <u>retracted</u> limit switch (“ON” when not “clicked”)</p>
OUTPUT LED'S	<p>OUT 1 : Acceleration signal “ON”</p> <p>OUT 2 : Packer is retracting or “retract” button (yellow) is “ON” or Packer fully <u>extended</u></p> <p>OUT 3 : Packer is extending or “start cycle” (green) button is “ON”</p> <p>OUT 4 : Multi-cycle output and Crusher panel enabled (Packer fully retracted)</p> <p>OUT 5 : PTO power (Cut by right outside Emergency Stop button)</p>

FIGURE #3.22

3.8 PACKER MULTI-CYCLE MODULE PROGRAMMING

The multi-cycle module is used to control the number of cycle the packer will do when the “Start Cycle” button (green) is pressed.



The number of cycles needs to be adjusted depending on the type of route the vehicle has to collect. For example, in a residential area, if the houses are numerous and close to one another, it may be required to increase the number of cycle. This will allow the hopper to be clear for the next house pickings.

Located inside the console, the multi-cycle module can be programmed to allow the packer to perform from 2 to 8 cycles. The factory default is 3 cycles. Each time the packer is completing a full cycle, a signal is sent to the packer module by the limit switch located on the R-H side, behind the packer. The module then counts the amount of cycles that the packer does. The module will stop the packer after the preset amount of cycles has been reached.

NOTE:

The multi-cycle feature is optional, and some unit may have different factory settings.

In order to increase or to reduce the number of cycle, use the set of DIP switches on the module (Figure #3.23). Refer to the following table (Figure #3.22) to set the module properly. The same table is found on the module (Figure #3.23).

MULTI-CYCLE PROGRAMMING TABLE

	OFF	1	2	3	4	5	6	ON
# of cycle								
		DIP SWITCH						
		1	2	3	4	5	6	
2								
3								
4								
5								
6								
7								
8								

FIGURE #3.22

MULTI-CYCLE MODULE

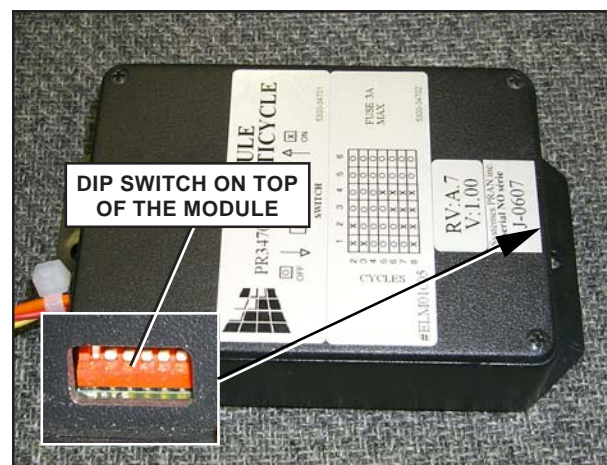



FIGURE #3.23

3.9 PACKER MULTI-CYCLE MODULE TROUBLESHOOTING

If the packer no longer performs the multi-cycling (more than one cycle) when the “start cycle” button (green) is pressed, apply the following procedure to verify the system:

TROUBLESHOOTING PROCEDURE

1. Make sure the DIP switch setting is within the rectangle setting found on the multi-cycle programming table (Figure #3.22); improper DIP switch setting could keep the packer from cycling.
2. Ensure that the “automatic cycle” button on the console is set to “ON”. 
3. Manually retract the packer using the “Retract” button (Yellow). 
4. Lower the crusher panel; if the crusher panel can move, this indicates that the limit switch behind the packer is working properly.
5. Make sure the 3 A fuse at the bottom of the module is not blown or loose in the socket (Figure #3.24). If the fuse appears to be loose in the socket, tighten the connector using the proper tool.
6. If the packer is still not functioning with multiple cycles, disconnect the module and using a voltmeter, check all the signals coming from the packer module on the connector.

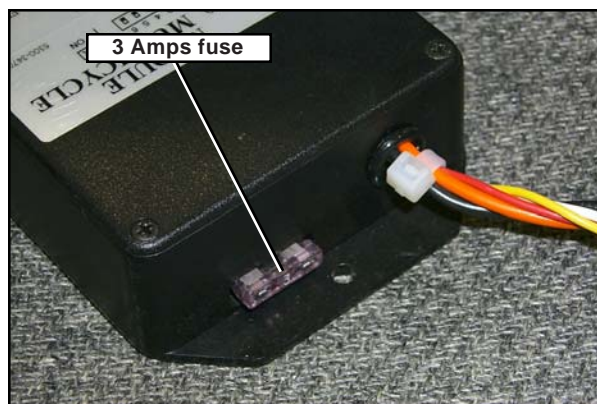

FIGURE #3.24

NOTE:

Always refer to the electrical schematic while troubleshooting.

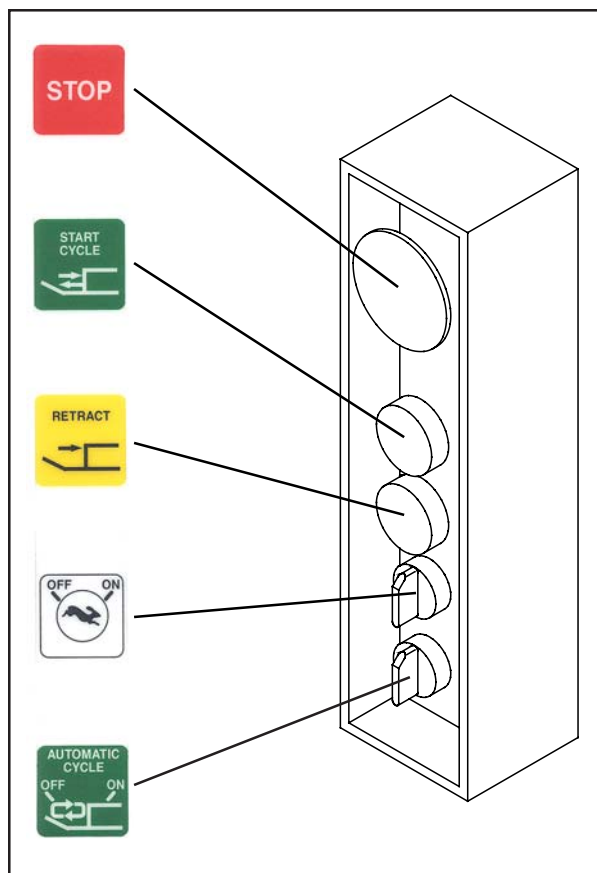

FIGURE #3.25

Continued on next page --->

3.9 PACKER MULTI-CYCLE MODULE TROUBLESHOOTING (Cont'd)

The multi-cycle module counts the number of time the packer reaches the fully retracted position. The limit switch sends pulses on wire #106 (retract signal). Until the preset amount of pulses is reached, the multi-cycle module will give an output signal on wire #107 (forward signal) for the packer to perform a complete cycle. This signal has the same effect as pressing on any "start cycle" button (green).

Before starting troubleshooting, make sure that all these conditions are met:

- 1) Parking brake is applied;
- 2) Engine is running (at idle speed);
- 3) Transmission in "Neutral";
- 4) All emergency stop buttons (red) are pulled out;
- 5) Pump switch (PTO) turned "ON";
- 6) There should be 12 volts on wire #147 at test point 1 (figure #3.33);
- 7) Multi-cycle switch "ON" (Figure #3.31);
- 8) Packer fully retracted;

When connecting a voltmeter on terminal 2 (wire #127) of the multi-cycle harness connector, it should read 12 volts. If not, follow the test points 1 through 6 to verify the path of multi-cycle module 12-volt supply.

Test the continuity between terminal 1 of multi-cycle module harness connector and the ground post inside the console; it must have good continuity. If not, check electrical connections.

When connecting a voltmeter on terminal 5 (wire #108) of the multi-cycle harness connector, it should read 12 volts. If not, follow the test points A through E to verify the path of the retracted packer signal.

NOTE:

Always refer to the main electrical schematic inside the console.

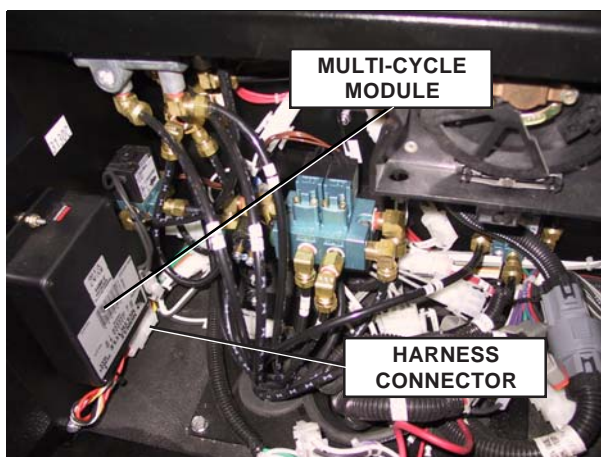
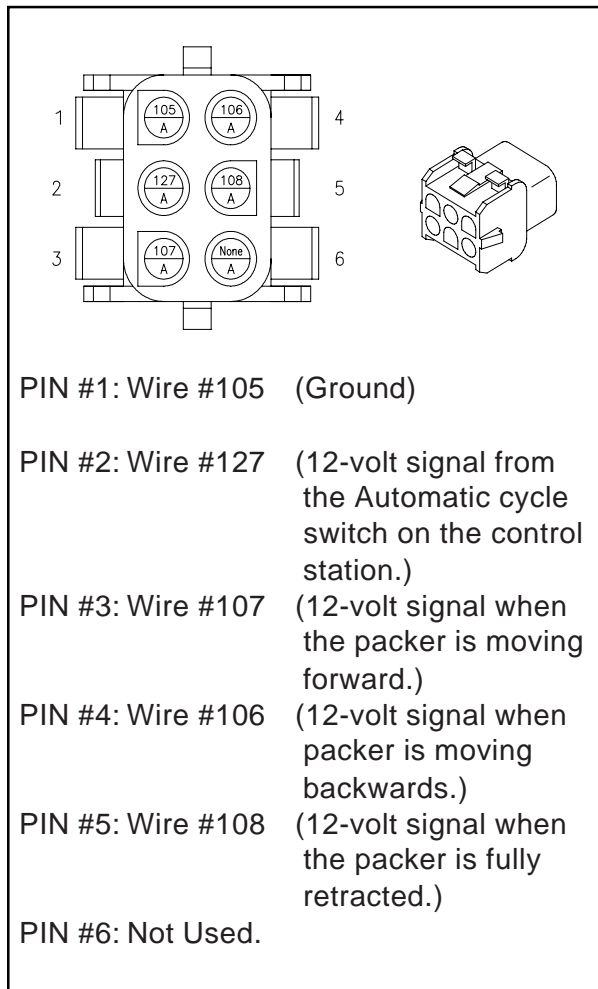
MODULE CONNECTOR LAYOUT**FIGURE #3.26**

CIRCUIT	DESCRIPTION	COLOR
105	GROUND	WHITE
106	RETRACT SIGNAL FOR AIR VALVE	YELLOW
107	FORWARD SIGNAL FOR AIR VALVE	GREEN
108	LIMIT SWITCH FULLY RETRACT N.O.	ORANGE
110	RIGHT CONTROL POWER	BLACK
111	LEFT CONTROL POWER	BLACK
127	POWER MULTI-CYCLE MODULE	RED
130	CAB CONTROL POWER	BLACK
136	POWER LIMIT SWITCH RETRACT	ORANGE
137	LIMIT SWITCH FULLY RETRACT N.C.	YELLOW
147	POWER TO P.T.O. SOLENOID	BLACK

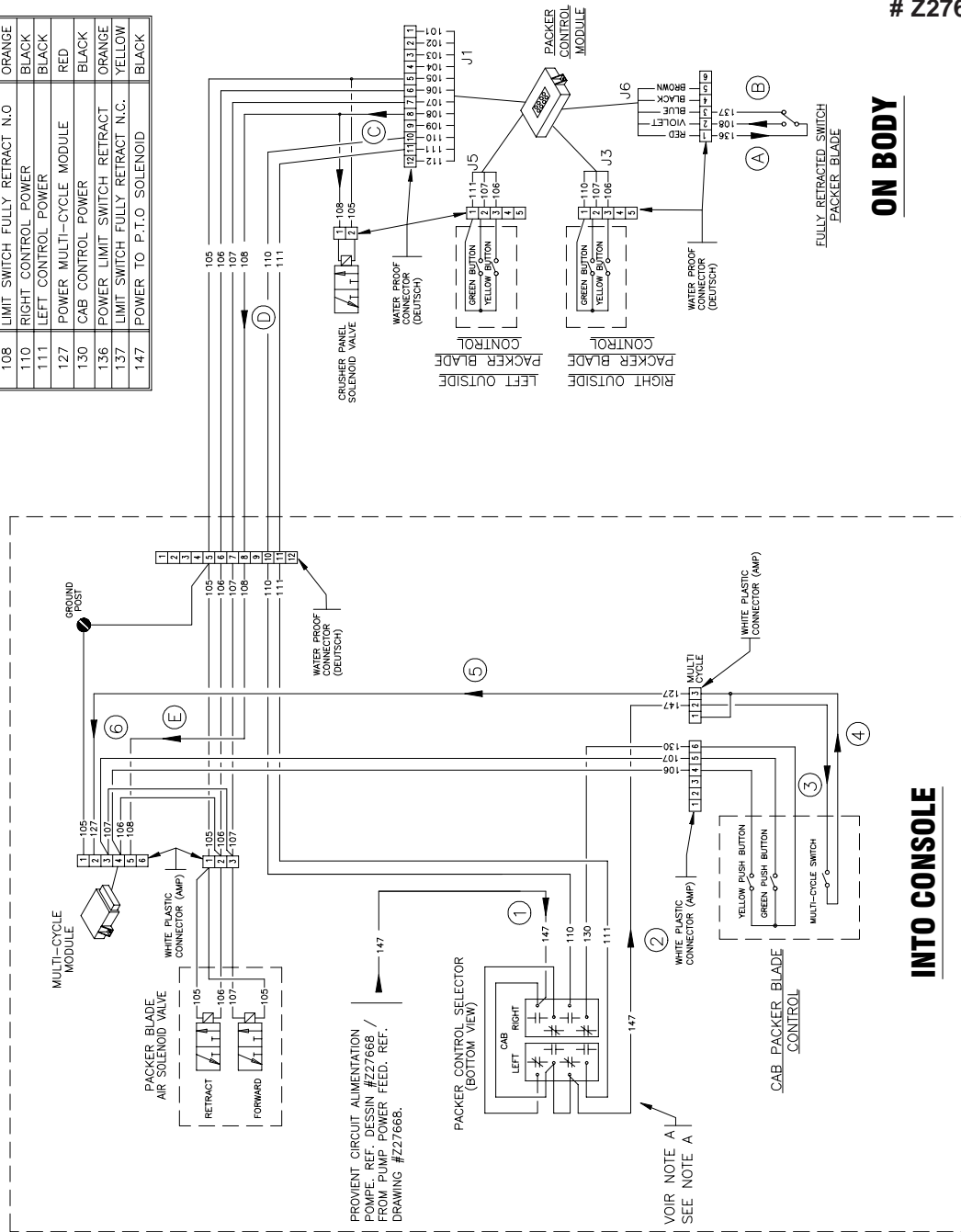

Z27669

ON BODY

INTO CONSOLE

FIGURE #3.27

PROVENT CIRCUIT ALIMENTATION POMPE. REF. DESSIN #Z27668 / FROM PUMP POWER FEED. REF. DRAWING #Z27668.

NOTE A
 CET INTERRUPTEUR, 3 POSITIONS, SERTE A ANGLISER LE 12V DU FIL 147 EN TROIS AUTRES FILS; (110, 111 & 130), UN ACTIF A LA FOIS. DE CETTE FACON UNE SEULE STATION DE CONTROL COMPACTEUR EST ACTIVE A LA FOIS.
 THIS 3 POSITIONS SWITCH IS USED TO DIRECT POWER OF WIRE 147 TOWARDS 3 OTHERS WIRES. (110, 111 & 130) ONE HOT AT A TIME. THIS WAY, ONLY ONE PACKER CONTROL STATION IS ENABLED AT A TIME.

3.10 ELECTRIC SCHEMATICS SYMBOLS

	6 outlets AMP or DEUTCH connector. (Typical)		10 fuses ATO fuse block (ELR00460)
	12-volt single pole N.O.-N.C. relay and base. (ELR00810) and base (ELR00860)		6" 12-volt strobe light (ELL02765)
	12-volt alternating flasher relay. (ELR 00700)		12-volt amber flashing light (ELL02855)
	55 PSI pressure switch N.O. installed on pneumatic line #1. (PNI00600)		12-volt work light (ELL01300)
	0-60 PSI adjustable pressure switch N.O. installed on pneumatic line # 1. (PNI00605)		12-volt backup alarm on chassis (ELA00700)
	12-volt solenoid valve (PNV01957).		Packer module (CL- ELM01005, CF- ELM01025)*
	12-volt dual solenoid valve for packer. (PNV01914)		Multi-cycle module (ELM01605)
	Bipolar switch (ELB02505)		2 N.O. , 2 N.C., 3 positions switch (ELB00260, 2 X ELB00270)
	N.C. limit switch (ELI00550, ELC00200 & ELI00850)		1A diode (ELD00100)
	Single pole switch.		Emergency red button (ELB002200)
	12-volt buzzer on console (ELR01000)	<p>*</p> <p>SF = AUTOMIZER</p> <p>CL = EXPERT 2000</p> <p>CF = OPTIMIZER</p> <hr/> <p>N.O. = NORMALLY OPEN</p> <p>N.C. = NORMALLY CLOSED</p>	
	12-volt red pilot light (PNI00500)		
	12-volt green pilot light. (PNI00500 & ELL00300)		
	To ground post into console.		
	12-volt solenoid.		
	12-volt speed-up air actuator. (PNC00250)	<p>Note: Part numbers are indicated within brackets</p>	
	10 A fuse (Typical)		

3.11 ALLISON TRANSMISSION PROGRAMMING PARAMETERS

The following section shows how the Allison electronic transmissions ECU are programmed for Labrie trucks.

If the ECU module of the Allison transmission is replaced, the ECU must be reprogrammed in order to set back the operating parameters of the vehicle. The transmission ECU module programming affects the engine speed, PTO engagement and operation, as well as the Auto-neutral system.

Refer to the following table to reprogram the transmission ECU:

<u>ALLISON</u> TRANSMISSION PROGRAMMING PARAMETERS	
PARAMETERS	AUTOMIZER™ and AUTOMATED EXPERT 2000™
Maximum engine speed for PTO Engagement:	900 RPM
Maximum engine speed for PTO Operation:	2300 RPM
Maximum output speed for PTO Engagement:	5000 RPM
Maximum output speed for PTO operation:	930 RPM*
Maximum output speed for Automatic Neutral:	200 RPM* (3 MPH)

* The value is adjusted in order to correspond to the truck's speed in Mph. It may vary according to the differential gear ratios and tire sizes.

The following wires must be activated:

- #117: Pack enable
- #118: Input PTO enable
- #112: Output PTO enable
- #153: Auto-neutral pack enable
- #114: Output Neutral indicator - PTO

NOTE:

On chassis supplied by Labrie Environmental Group, the programming package for Allison Transmissions is #142.

Some Customer's chassis may have different programming packages. Refer to your local Allison dealer for original programming packages. For further information regarding ECU programming, contact the Labrie Service Department.

Parameters shown in this table are applicable on all Automizer™ units, but also on automated Expert 2000 units equipped with a Cool Hand™.

3.12 ENGINE PROGRAMMING PARAMETERS

As the engine programming parameters change according to the truck model, call Labrie to know which parameters apply to your truck.

The ideal idle speed is 825 RPM, but for certain engines, it is impossible to increase the idle speed or even to reach an idle speed of 825 RPM.

3.13 CYLINDER INTERNAL LEAK DETECTION

An internal leak is caused by a damaged seal inside the hydraulic cylinder (1). Because the cylinder is leaking oil inside (bypassing), a certain amount of pressure is lost reducing the cylinder efficiency and its capacity to push or pull.

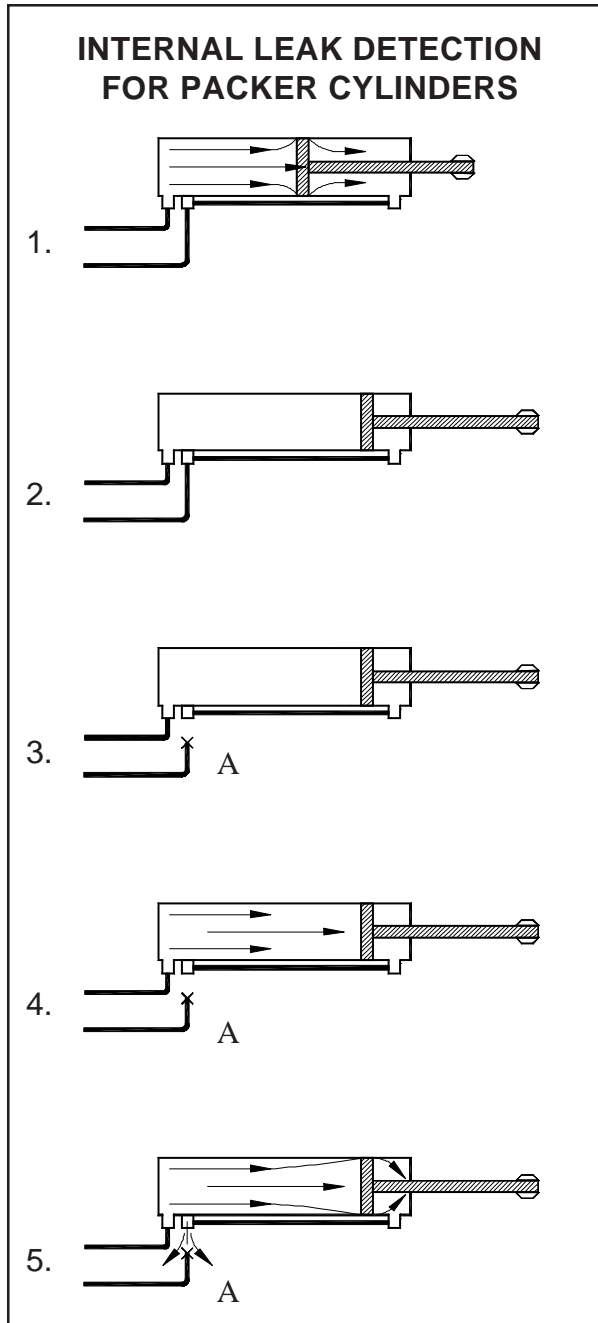

FIGURE #3.28

If the packer cylinders are bypassing, the seal inside the cylinder may require to be replaced. If an internal leak is suspected, apply the following procedure to verify it:

INTERNAL LEAK DETECTION FOR PACKER CYLINDERS

1. Apply all safety measures to ensure safety around the vehicle at all times.
2. Ensure that the parking brake is applied.
3. Pull out the Emergency Stop Button (red).
4. Start the engine and engage the hydraulic pump.
5. Fully extend the packer cylinders.
6. Disengage the hydraulic pump.
7. Disable the fully extend limit switch located on the L-H side, by removing the arm of the limit switch. This will prevent the packer from returning to its initial position.
8. Disconnect hose "A" and install a plug at the end of it.
9. Engage the hydraulic pump.
10. Press the green button and see if oil is leaking from port "A", then press the Emergency Stop Button.
11. If oil leaks out from port "A" when pressure is applied, this could mean there is an internal leak.
12. Replace or repair the cylinder.

NOTE: It should be necessary to do the procedure in retract position.

3.14 TAILGATE LOCKING MECHANISM TROUBLESHOOTING

The tailgate locking mechanism is equipped with hydraulic safety systems that prevent accidental unlocking of the tailgate during operation. One of the systems is the velocity fuse with the “**power bleed**” and the other is the holding valve.

The spool inside the tailgate section of the valve is designed in such a way that it will allow pressure to pass through it each time the pressure is building up in the hydraulic system (i.e.: when the packer is working). The pressure “burst” goes to the holding valve into port “D1” and then out to the cylinder by port “U1”. This will keep the tailgate cylinders pressurized and the tailgate closed when packing material.

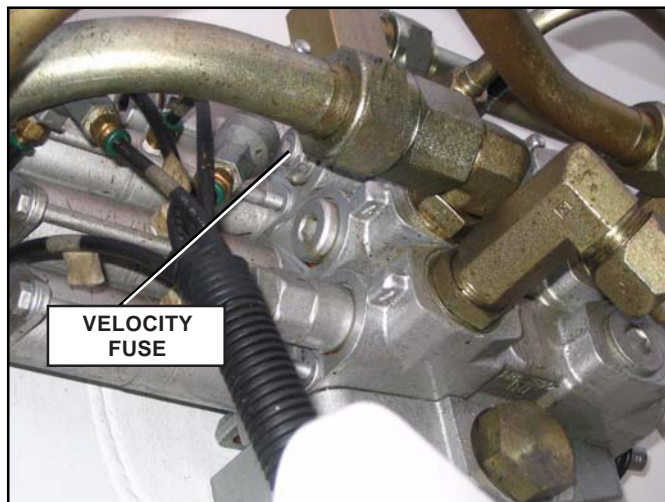

FIGURE #3.29

The velocity fuse, located on the left-hand side of the valve (Figure #3.29), will make sure to drain any slow moving oil coming from the piston side of the tailgate cylinders. Since the rod side is being pressurized with the “Power bleed” system, the other side has to drain to avoid any pressure build-up. The velocity fuse makes the piston side open to tank when the oil flow is very slow and will shut when a flow signal is sent.

NOTE:

Refer to the main hydraulic schematic (Figure #3.33).

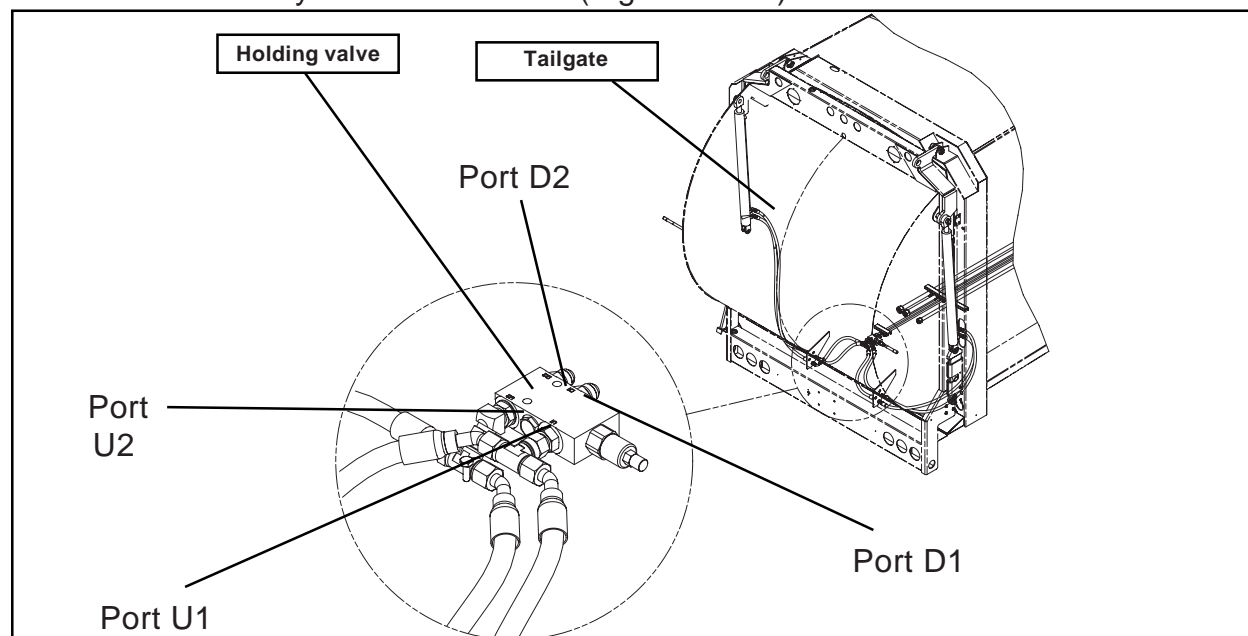

FIGURE #3.30

3.14 TAILGATE LOCKING MECHANISM (cont'd)

Problem #1:

Tailgate is UNLOCKING by itself

If the tailgate seems to unlock by itself when using the packer, the “power bleed” inside the valve might not work on the right side of the hydraulic cylinder. Apply the following procedure:

TAILGATE HYDRAULIC TROUBLESHOOTING

1. Apply all safety measures to ensure safety around the vehicle at all times.
2. Ensure that the parking brake is applied.
3. Pull out the Emergency Stop Button.
4. Install a pressure gauge on each port of the tailgate section on the valve, as shown on figure #3.31.
5. Start the engine and engage the hydraulic pump.
6. Disable the fully extend limit switch located on the L-H side, by removing the arm of the limit switch. This will prevent the packer from returning to its initial position.
7. Press on the “Start cycle” button (green) to start the packer and pressurize the system.

8. Gauge #1 should always indicate 0PSI and gauge #2 should indicate a sudden pressure burst between 0 PSI to 3000 PSI each time the packer reaches the end of a stroke.
9. If gauge #1 indicates pressure, this may be caused by a faulty holding valve, faulty velocity fuse or hydraulic hoses not properly connected. Refer to the main hydraulic schematic for proper connection.

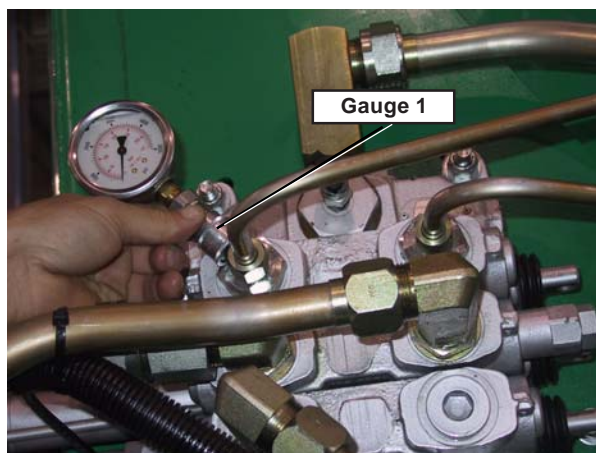

FIGURE #3.31

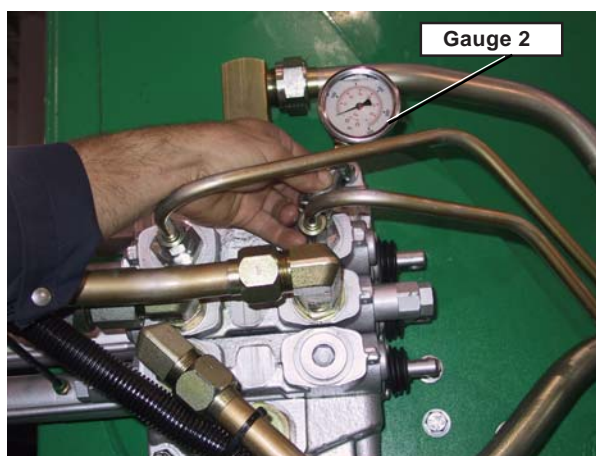

FIGURE #3.32

NOTE: The figures above show only the places where to install the gages. To install these gages, use appropriate fittings.

Problem #2:**Tailgate is LOWERING by itself**

One other problem that may be found on the tailgate hydraulic system is that it would lower by itself. A faulty velocity fuse might be involved. Apply the procedure below in order to verify and /or replace the velocity fuse.

**TAILGATE HYDRAULIC
TROUBLESHOOTING**

- 9. Apply all safety measures to ensure safety around the vehicle at all times;**
- 10. Ensure that the parking brake is applied;**
- 11. Remove the velocity fuse (Figure #3.29) and verify that it is clean and that the plunger is moving freely. A new velocity fuse may be necessary.**

Page intentionally left blank

3.15 MAIN HYDRAULIC SCHEMATIC

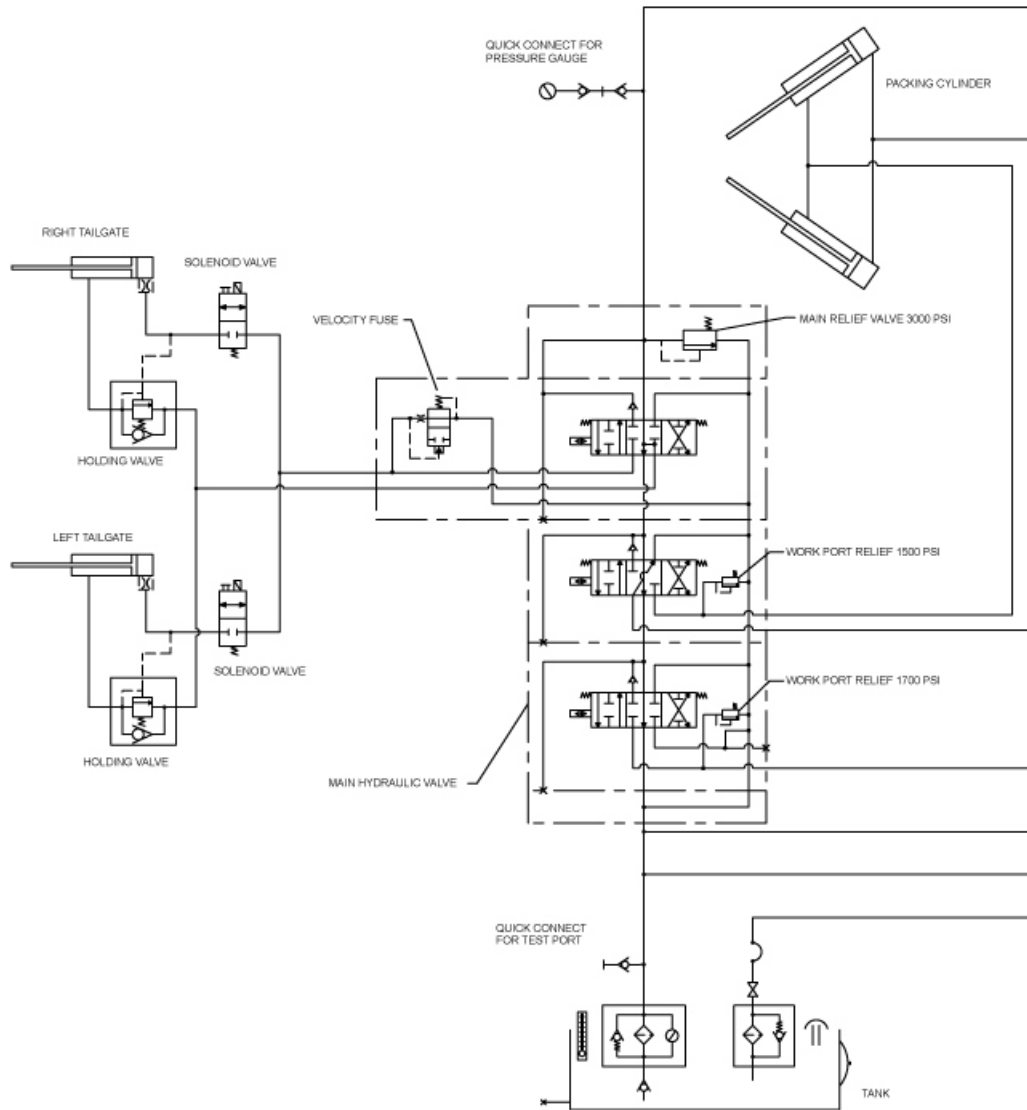
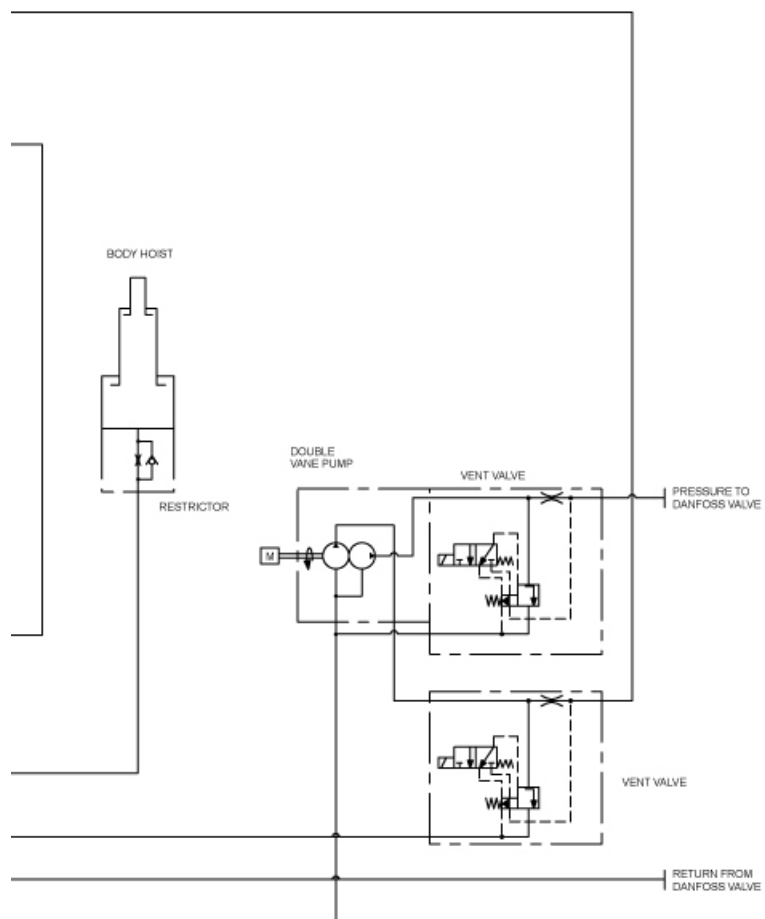
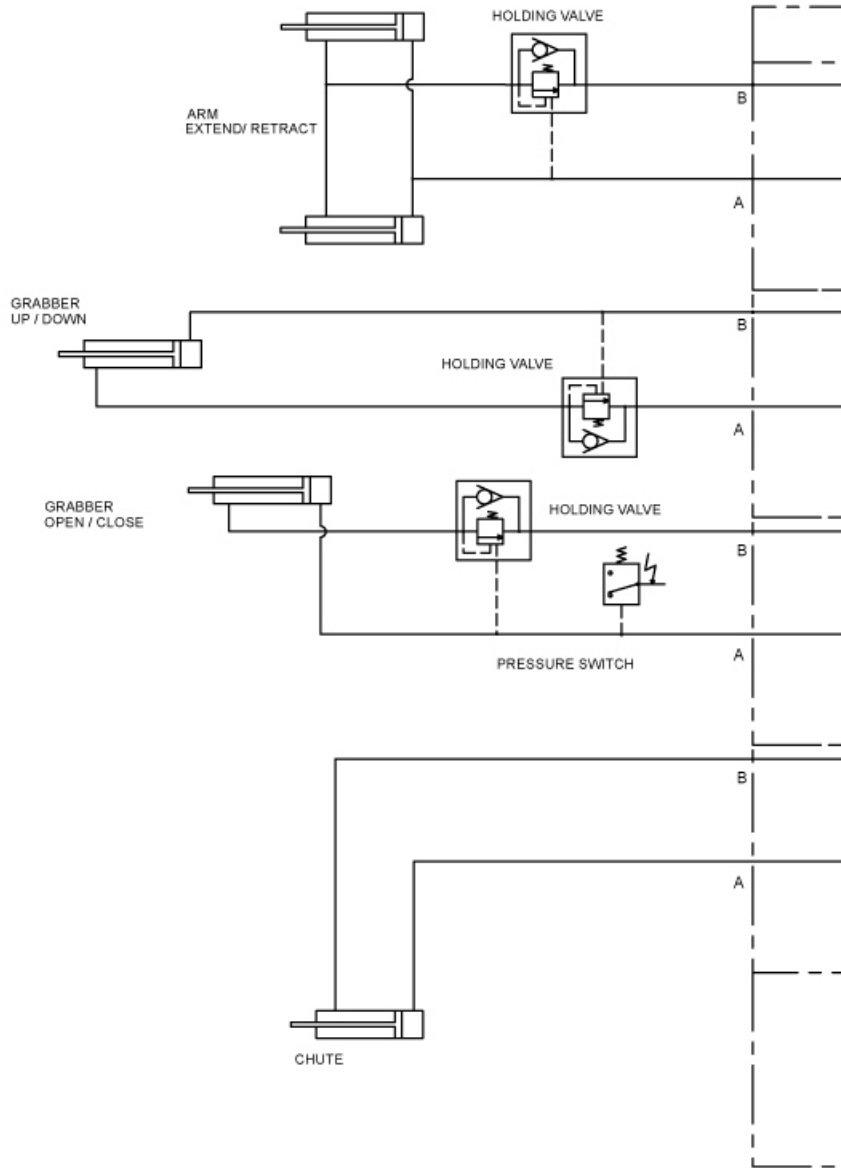

FIGURE #3.33



3.16 AUTOMATED ARM HYDRAULIC SCHEMATICS



NOTE: VALVE WITH CHUTE SECTION SHOWN (96-GALLON GRABBER)

FIGURE #3.34

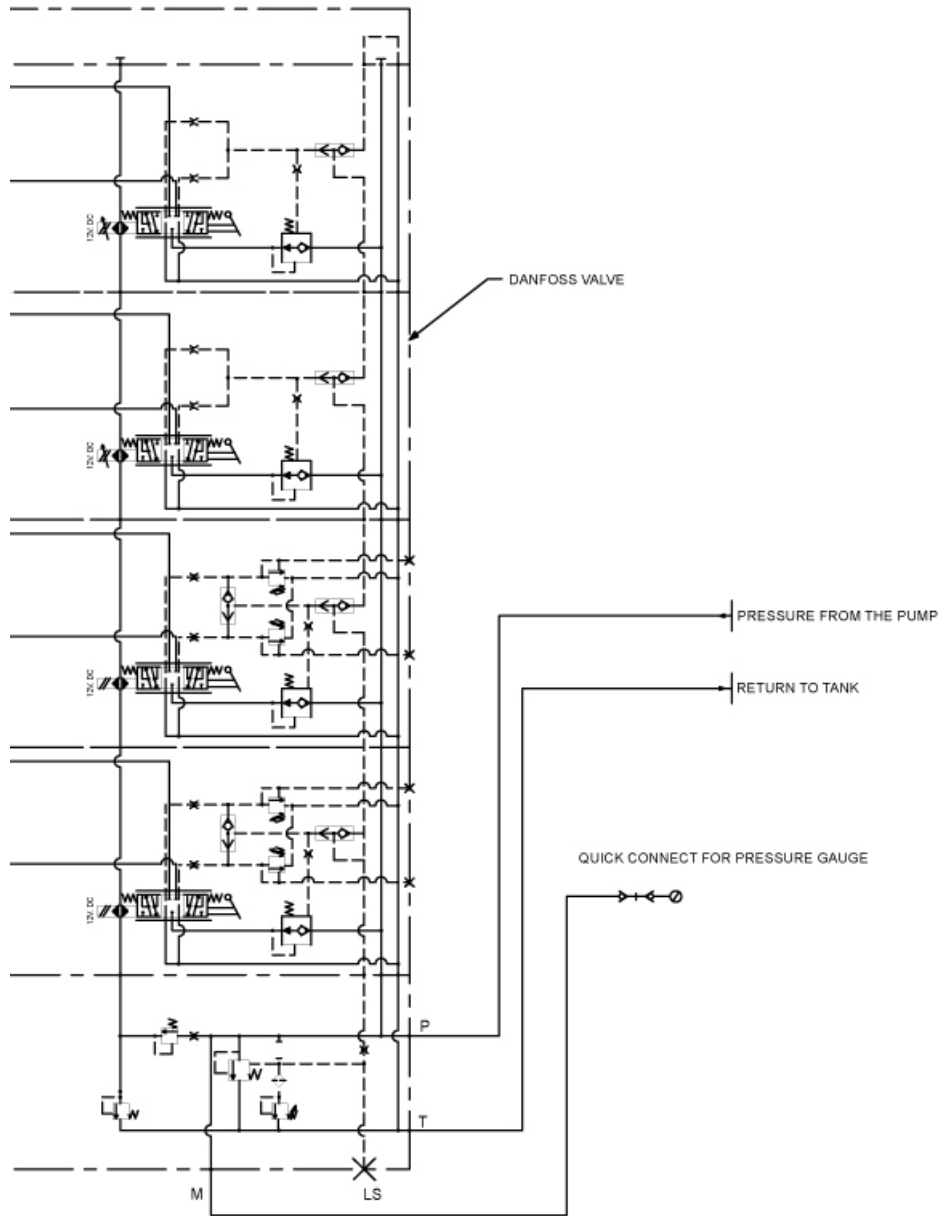

3.16 AUTOMATED ARM HYDRAULIC SCHEMATICS

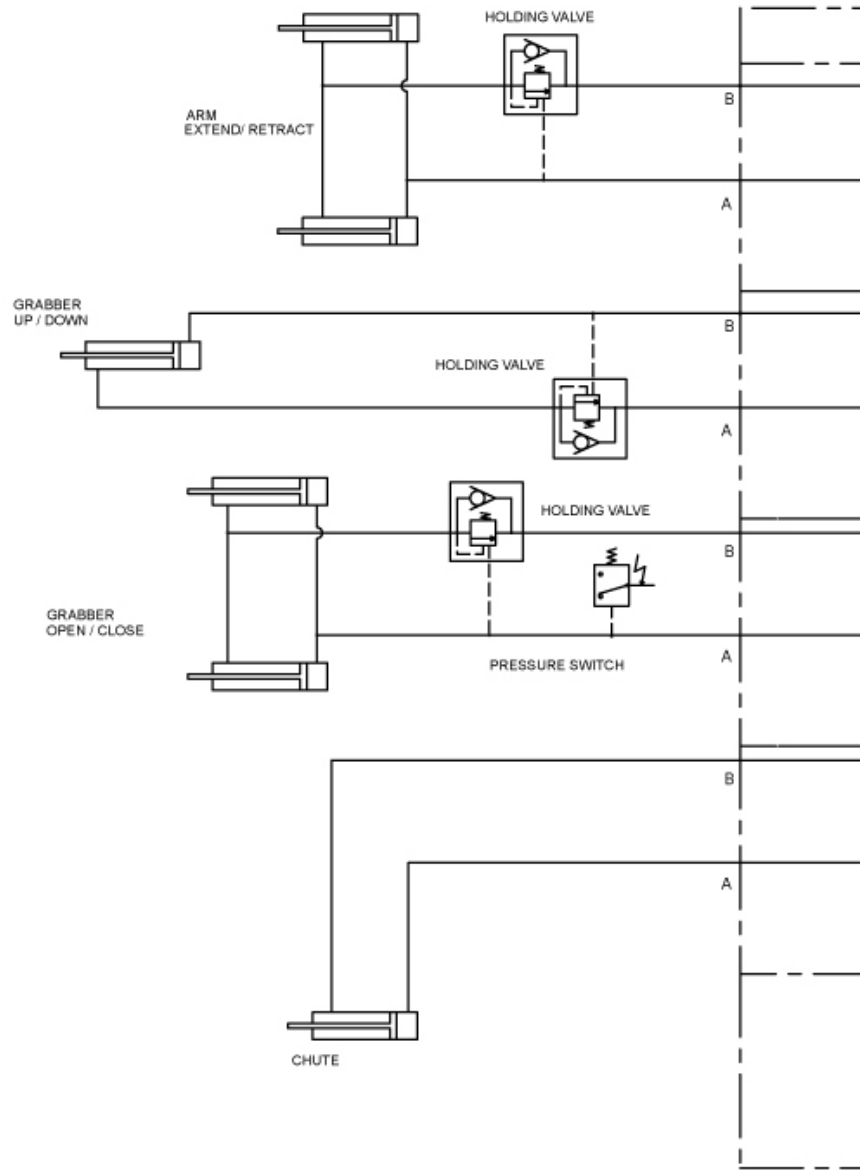

NOTE: VALVE WITH CHUTE SECTION SHOWN (300-GALLON GRABBER)

FIGURE #3.35

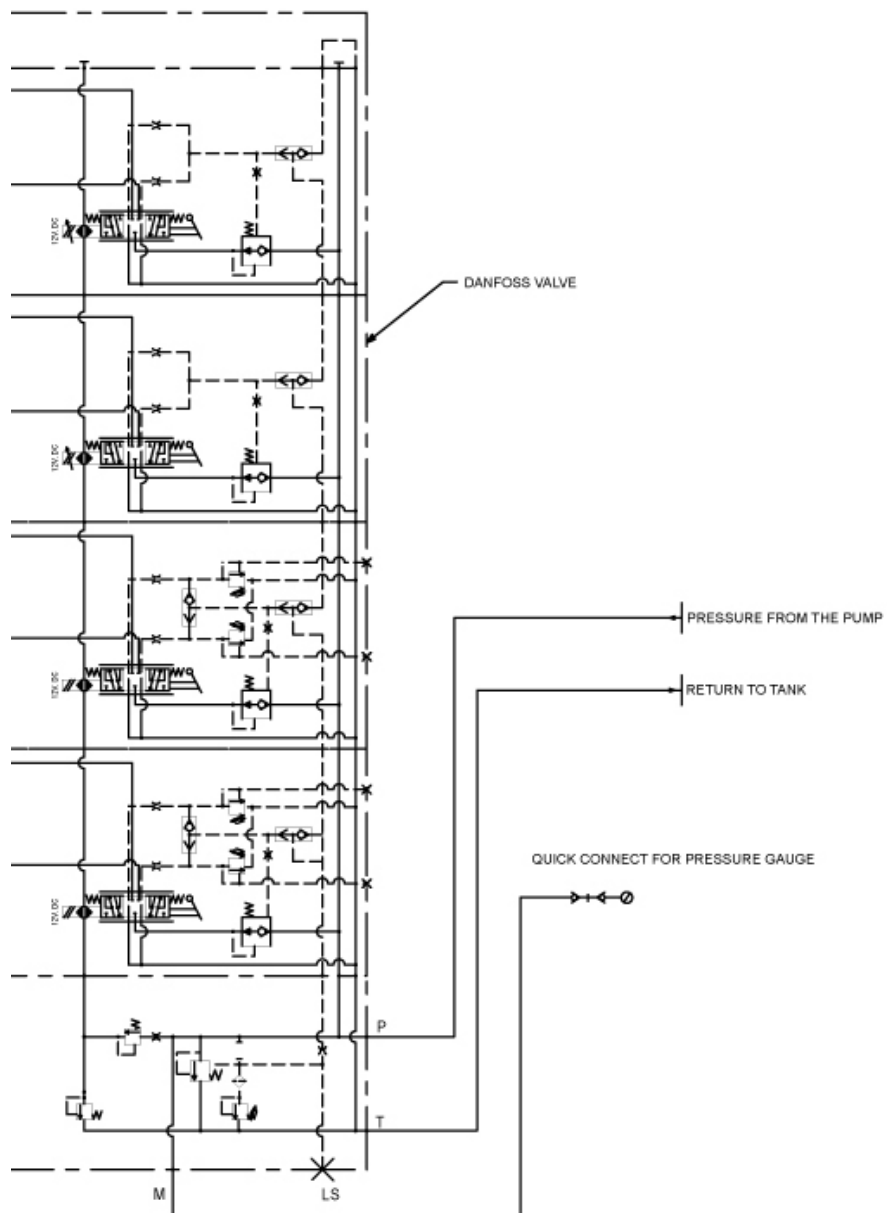

3.16 AUTOMATED ARM HYDRAULIC SCHEMATICS

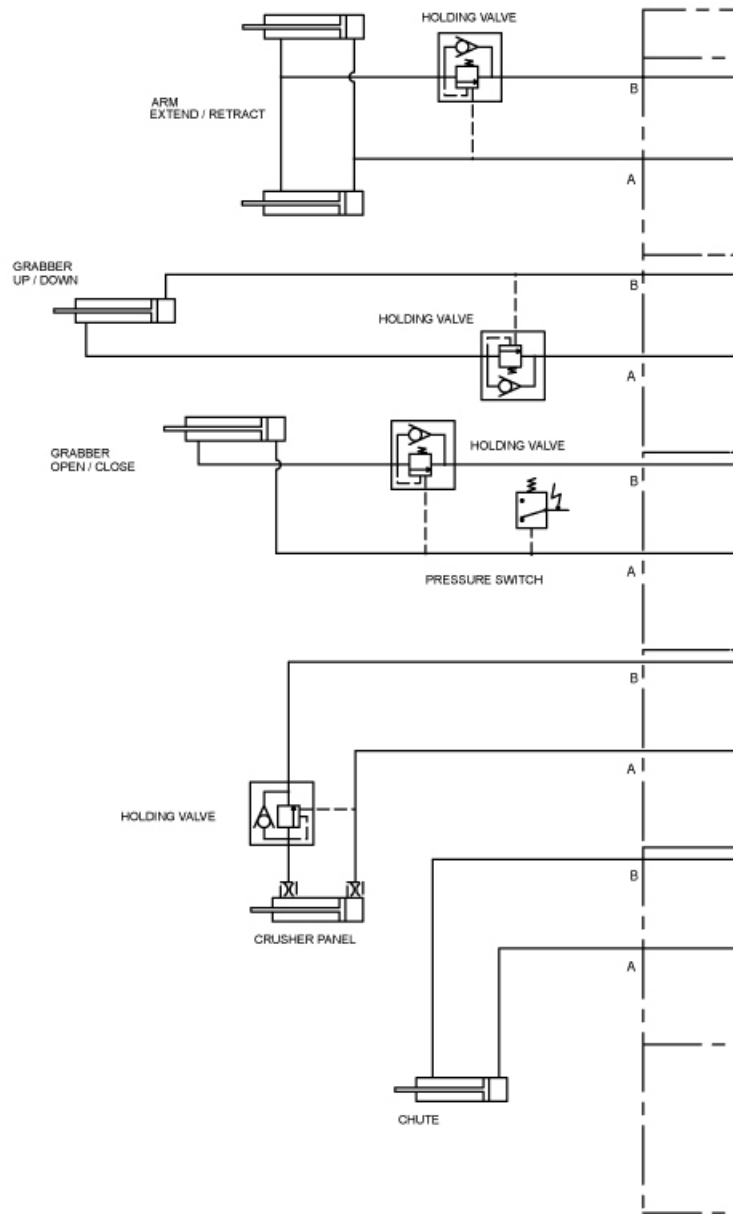

NOTE: 5-SECTION VALVE SHOWN (96-GALLON GRABBER)

FIGURE #3.36

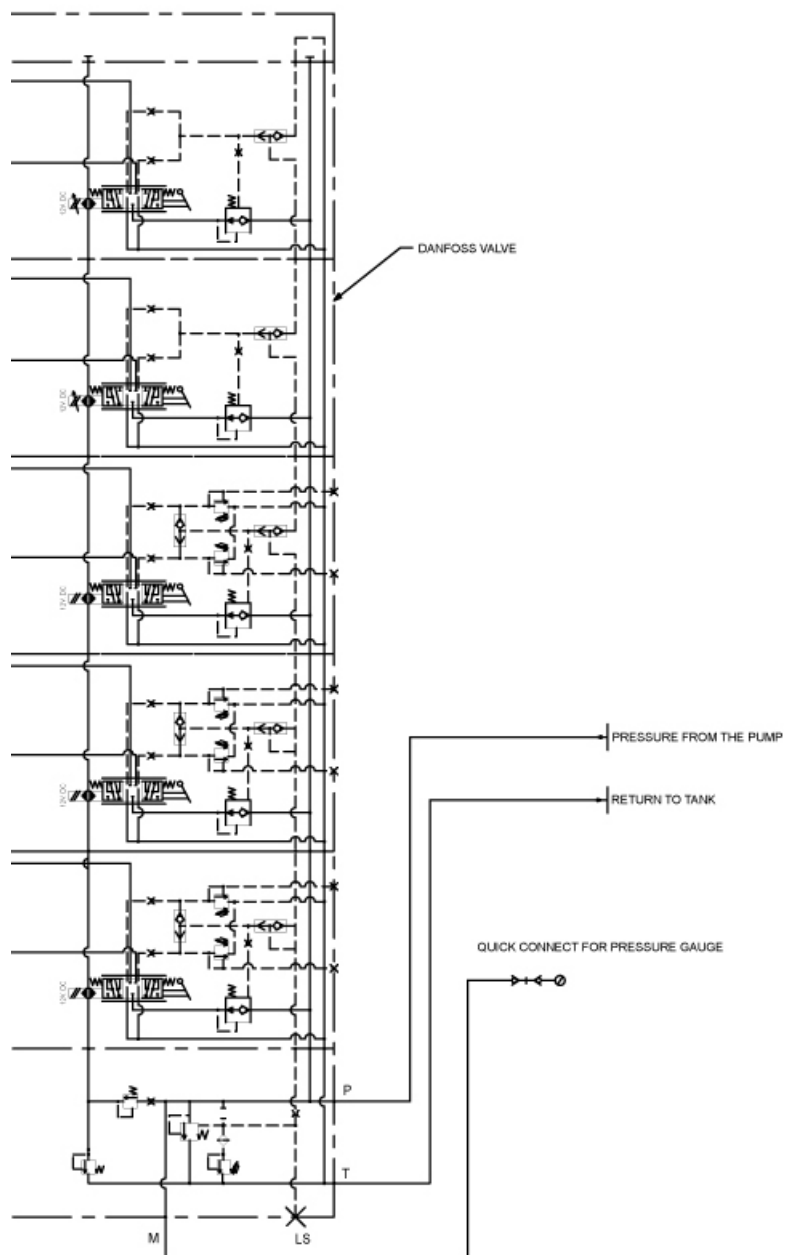

3.16 AUTOMATED ARM HYDRAULIC SCHEMATICS

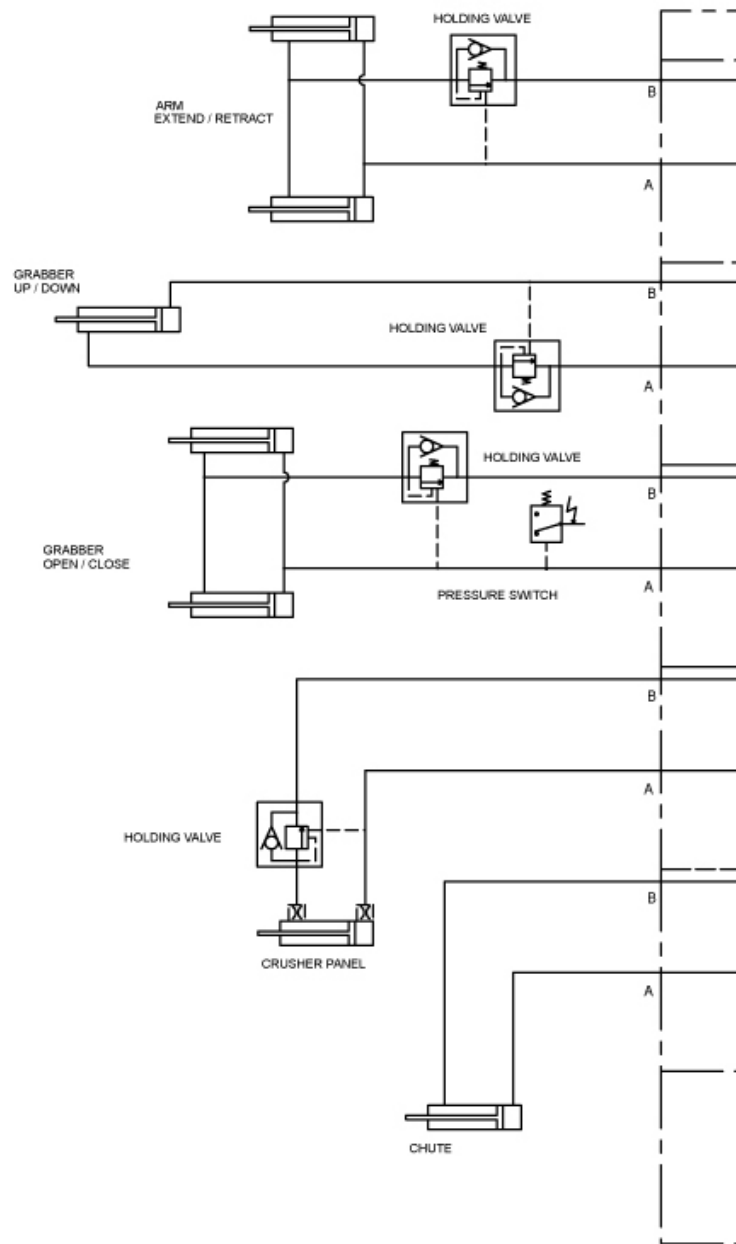

NOTE: 5-SECTION VALVE SHOWN (300-GALLON GRABBER)

FIGURE #3.37

